



3-2720.090-1

D 8/04

English



SAFETY INSTRUCTIONS FOR IN-LINE ELECTRODE INSTALLATION

1. Do not remove from pressurized lines.
 2. Do not exceed maximum temperature/pressure specifications.
 3. Wear safety goggles or face shield during installation/service.
 4. Do not alter product construction.
- Failure to follow safety instructions may result in severe personal injury!



1. Wiring

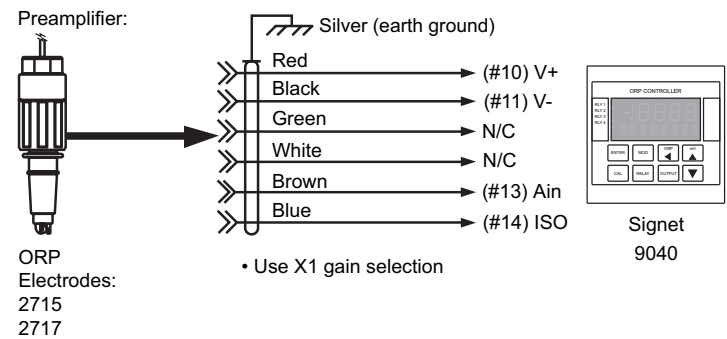
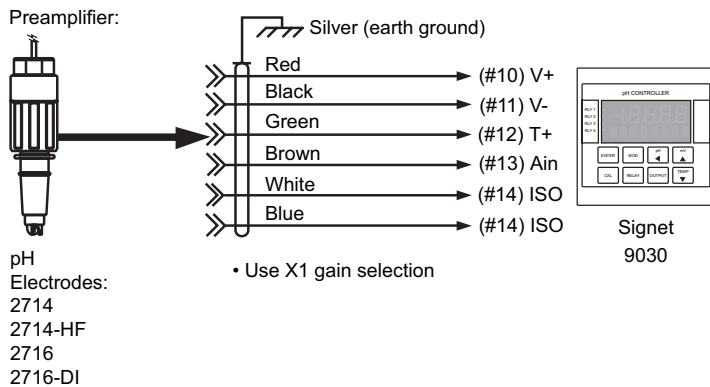
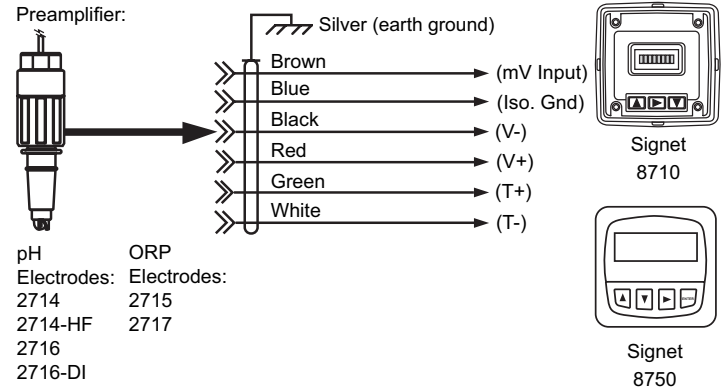
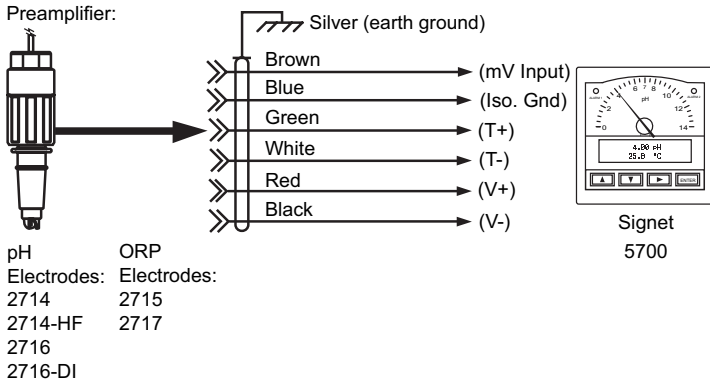

Technical Notes:

- Use 6-conductor shielded cable for cable extensions to 120 m (400 ft)
- Shield must be maintained through cable splice

2. Signet Fittings

Type	Description
<p>Plastic tees</p>	<ul style="list-style-type: none"> • 0.5 to 4 in. • PVC or CPVC • Mounts via glue-on fittings
<p>PVC saddles</p>	<ul style="list-style-type: none"> • 2 to 4 in., use 1-7/16 in. hole in pipe • Align wedge arrows with saddle arrows during assembly.
<p>Iron strap-on saddles</p>	<ul style="list-style-type: none"> • 2 to 4 in., use 1-7/16 in. hole in pipe

Type	Description
<p>Carbon steel weld-on weldolets</p>	<ul style="list-style-type: none"> • 2 to 4 in, use 1-7/16 in. hole in pipe • Remove insert before welding • Installed by certified welder only
<p>Carbon steel threaded tees</p>	<ul style="list-style-type: none"> • 0.5 to 2 in. • Mounts on threaded pipe ends
<p>Universal pipe adapter for large pipes, #P31515-OV200</p>	<ul style="list-style-type: none"> • For existing pipe fittings 2 in. and up • External 1-1/4 inch NPT male threads

Consult your local Signet distributor for additional fitting information.

3. Recommended Position

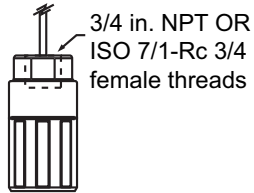

- Customer supplied:
- 3/4 in. NPT nipple (male)
 - J-box
 - flex conduit

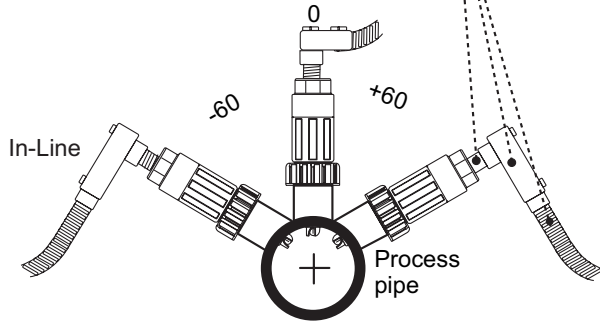

- Vertical (0°) position optimum
- 3m/s (10ft/s) or less for max. performance and sensor life

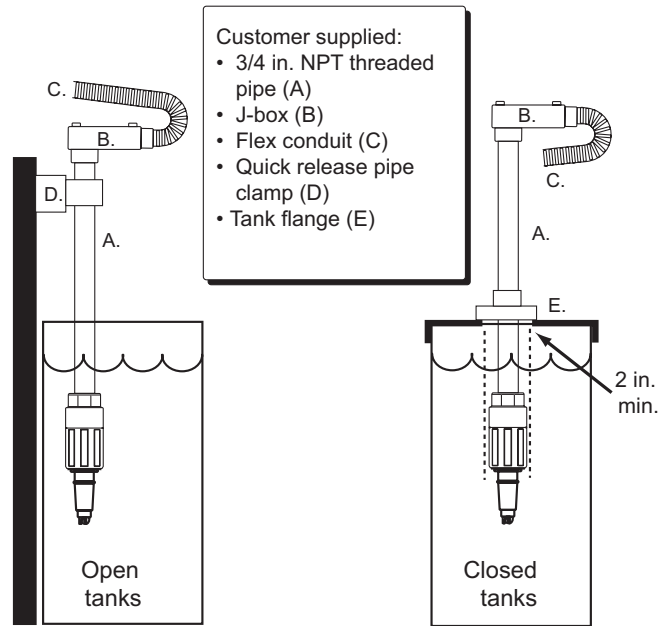

- Customer supplied:
- 3/4 in. NPT threaded pipe (A)
 - J-box (B)
 - Flex conduit (C)
 - Quick release pipe clamp (D)
 - Tank flange (E)

Caution: If liquid level is not constant, always ensure liquid contact with electrode tip

4. Installation

In-line Applications

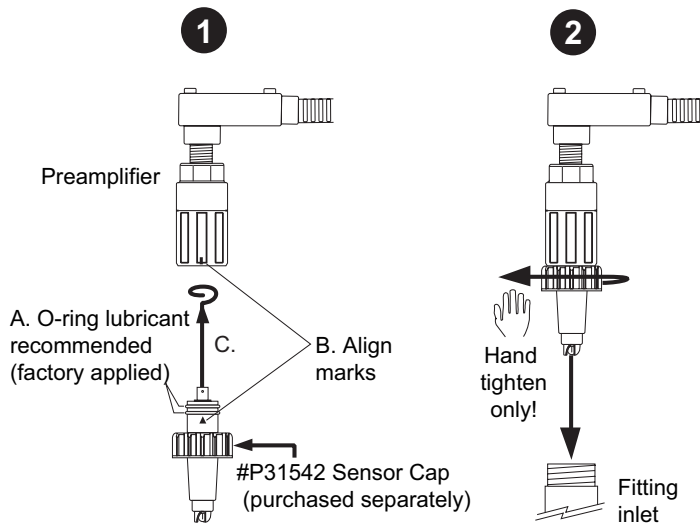

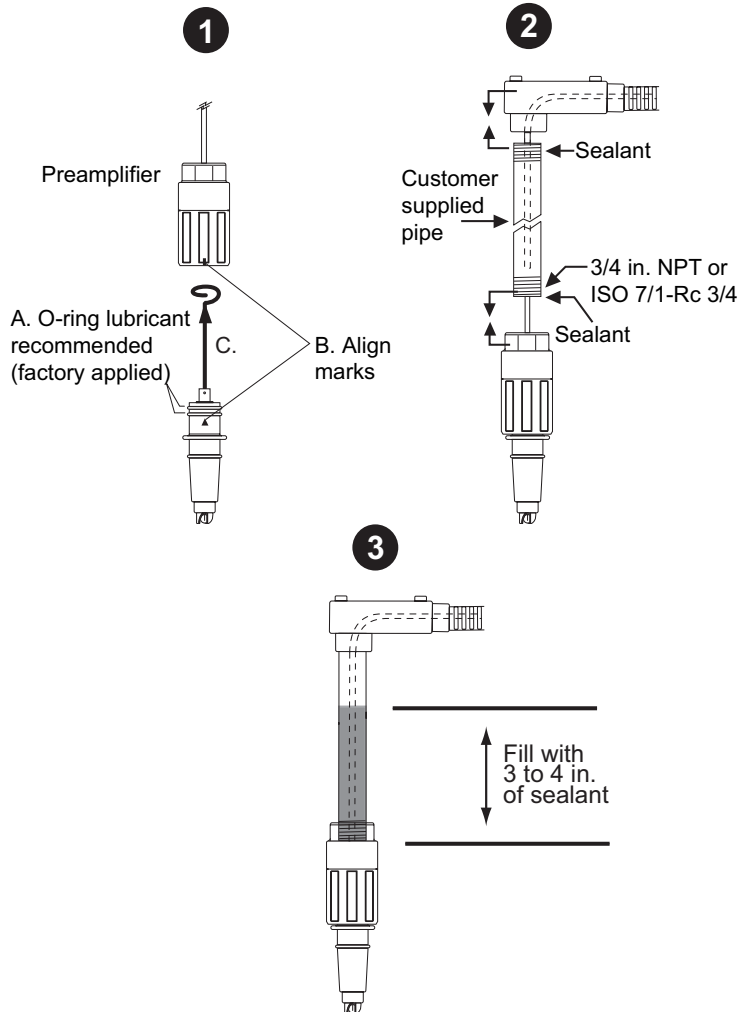

Submersible Applications



Attach 3/4 in. watertight pipe to the top of the 2720. Secure the threaded connection to prevent any leakage. For additional defense against possible accumulation of condensation at the back seal area of the sensor, fill the lower 3 to 4 inches of conduit or extension pipe with a flexible sealant such as silicone.

5. Accessories

Part no.	Description	Material	Code
P31542	Sensor cap 	PP	198 801 630
1220-0021 1224-0021 1228-0021	Sensor O-ring, 2 required 	FPM EPR FFKM	198 801 186 198 820 006 198 820 007



CAUTION!

When replacing O-rings, apply O-ring lubricant to sensor O-rings prior to preamplifier/electrode assembly. Unlubricated O-rings may score the preamplifier sealing surface.

6. Specifications

Signet 2720 Twist-Lock pH/ORP Preamplifier

Housing material: CPVC

Compatible sensors: 2714 Flat Surface pH Electrode
2714-HF Flat Surface pH Electrode
2715 Flat Surface ORP Electrode
2716 Bulb pH Electrode
2716-DI Bulb pH Electrode
2717 Bulb ORP Electrode

Input Impedance: $>10^{11} \Omega$

Operating temp.: 0 to 80°C

Gain: X1 (unity)

Input power: ± 4.5 to ± 8 VDC, dual supply

Current consumption: <1 mA, dual supply

Quality standard: CE

Dimensions:

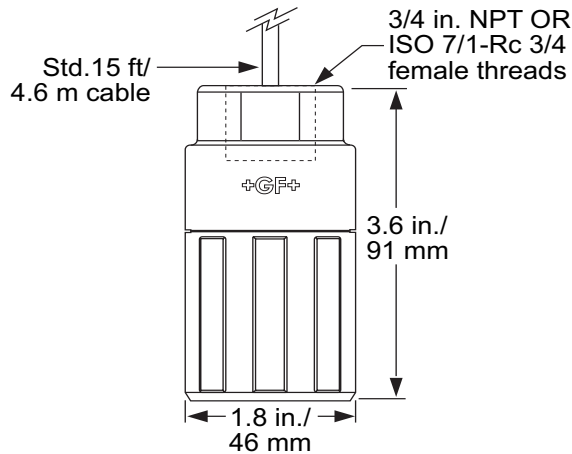

Signet pH/ORP Electrodes

General Specifications

Wetted parts:

Sensor body: CPVC

O-rings: FPM

Electrode junction: Porous UHMW polyethylene

Quality standard: CE

Maximum pressure/temperature ratings:

- 7 bar (100 psi) max. @ 65°C (149°F)
- 4 bar (58 psi) max. @ 85°C (185°F)

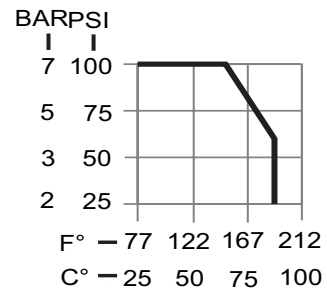

SAFETY INSTRUCTIONS FOR IN-LINE ELECTRODE INSTALLATION

1. Do not remove from pressurized lines.
2. Do not exceed maximum temperature/pressure specifications.
3. Do not install/service without following installation instructions (see sensor manual).
4. Wear safety goggles and faceshield during installation/service.
5. Do not alter product construction.
6. Failure to follow safety instructions could result in severe personal injury!

7. Preamplifier Troubleshooting

Procedure:

- A. Install sensor adapter into preamplifier
- B. With preamplifier and instrument connected, simulate pH 4, 7, and 10 and record displayed mV readings (right) and approximate preamplifier response time between simulations.
- C. Refer to table on next page for preamplifier troubleshooting tips.

Simulator Input	Actual displayed mV
4.00, +177 mV	_____
7.00, 0 mV	_____
10.00, -177 mV	_____
Preamplifier response time:	_____

With simulator connected	Error Condition	Possible Cause	Possible Remedy
	A) mV output stuck at zero B) mV output erratic C) mV output stuck at 1.4 VDC	A) Shorted input signal B) Faulty preamplifier or wiring C) Faulty preamplifier	A) Check preamplifier cable connections and shielding. B) Verify preamplifier shield connections. Verify cable shield wire has been maintained through each cable splice. C) Replace preamplifier
Okay with simulator connected but fails with electrode	A) mV output stuck near zero B) mV output erratic C) Output stuck at 1.4 VDC	A) Cracked electrode glass B1) Poor contact between electrode and preamplifier connectors B2) Fouled electrode reference or aged electrode B3) Ground loop C) Faulty preamplifier	A) Replace electrode B1) Check contacts between electrode and preamplifier. Contacts must be clean and dry. B2) Clean electrode, see electrode manual B3) Isolate electrode in test beaker. If output is stable, ground loops may exist causing erratic behavior; isolate instrument outputs (i.e. 4 to 20 mA, 0 to 5 VDC).

8. Electrode Maintenance and Cleaning

8.1 Maintenance

Variables can affect long term pH or ORP electrode life. For this reason, a maintenance log is recommended for trend analysis. When storing boxed sensors, lay the sensor flat to maximize hydration of the glass surface. Keep the glass surface wet at all times. Soak the sensor tip in pH 4.0 buffer during system maintenance intervals. In-line applications should be plumbed with a depression (trap) which ensures liquid is maintained around the sensor tip. If sensor dehydration has occurred, soak the sensor tip in pH 4 buffer for 24 to 48 hours, then visually inspect the electrode for surface cracks, swelling, or discoloration.

8.2 Cleaning

Cleaning techniques vary depending on the type of coating present on the glass electrode surface or reference junction.

- Soft coatings: can be removed by vigorous stirring, or with directed spray of an applicable detergent or solvent onto the glass electrode surface. Chlorine bleach or mild detergent may be used to remove soft coatings. Always rinse electrode tip in clean water after cleaning.

- Hard coatings: can be chemically removed. Always use the least harsh chemical which will remove the contaminant within two (2) minutes without attacking the materials of construction. e.g. calcium carbonate may be removed with a 5% HCL (muriatic acid) solution.
- Oily or Organic Coatings: can be removed with detergents or an appropriate solvent that does not attack the materials of construction e.g. isopropyl alcohol may be used but acetone must be avoided to prevent damage to the CPVC sensor body.
- ORP electrode surface (platinum rod): can be gently sanded with 600 grit wet and dry silicone or carbide sandpaper, jewelers rouge, crocus cloth, or very fine steel wool.



WARNING!

When using chemicals or solvents care should be taken and appropriate eye, face, hand, body, and/or respiratory protection should be used.

9. Replacement parts and accessories

Mfr. Part No.	Code	Description
3-2720	198 864 602	Preamplifier, 3/4 in. NPT
3-2720-2	198 864 603	Preamplifier, ISO 7-R 3/4 in.
3-2714	198 844 300	Flat pH Electrode
3-2714-HF	198 844 305	Flat pH Electrode, HF Resistant
3-2715	198 844 301	Flat ORP Electrode
3-2716	198 844 302	Bulb pH Electrode
3-2716-DI	198 844 306	Bulb pH Electrode, DI Resistant
3-2717	198 844 303	Bulb ORP Electrode
3-2759	159 000 762	pH/ORP Simulator/System Tester
3-2759.393	159 000 765	Adapter Cable for use with 2720
3-0700.390	198 864 403	pH Buffer Kit

3-2759 pH/ORP Simulator/System Tester

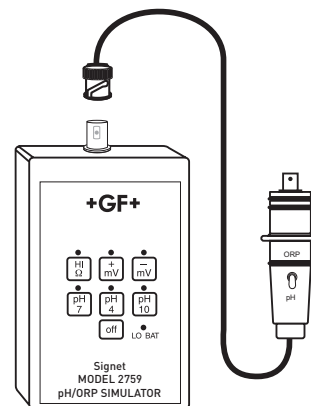

George Fischer Signet, Inc. 3401 Aerojet Avenue, El Monte, CA 91731-2882 U.S.A. • Tel. (626) 571-2770 • Fax (626) 573-2057
For Worldwide Sales and Service, visit our website: www.gfsignet.com • Or call (in the U.S.): (800) 854-4090

